

## OPIS TECHNICZNY

## PLATFORMA

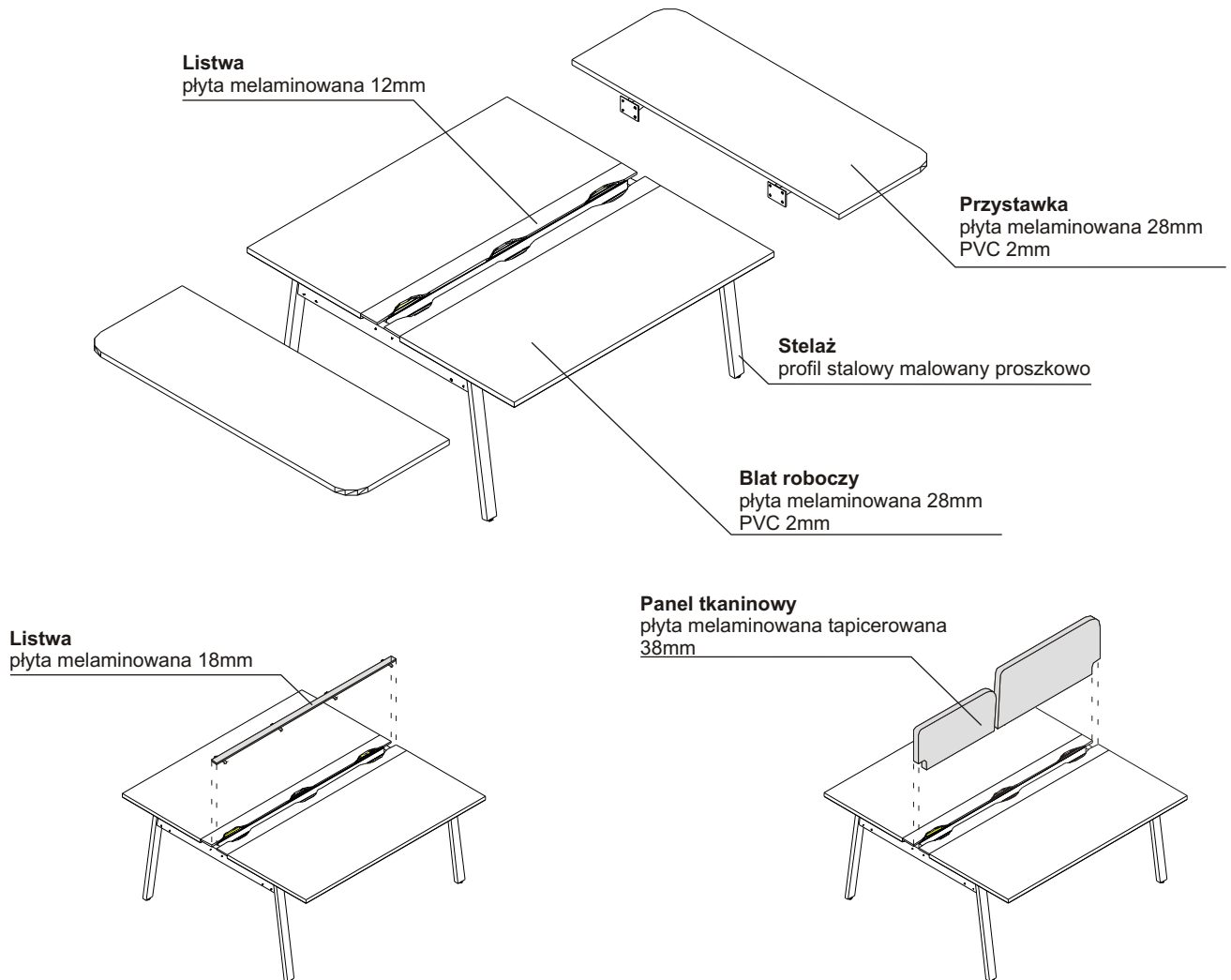

## KONTENER

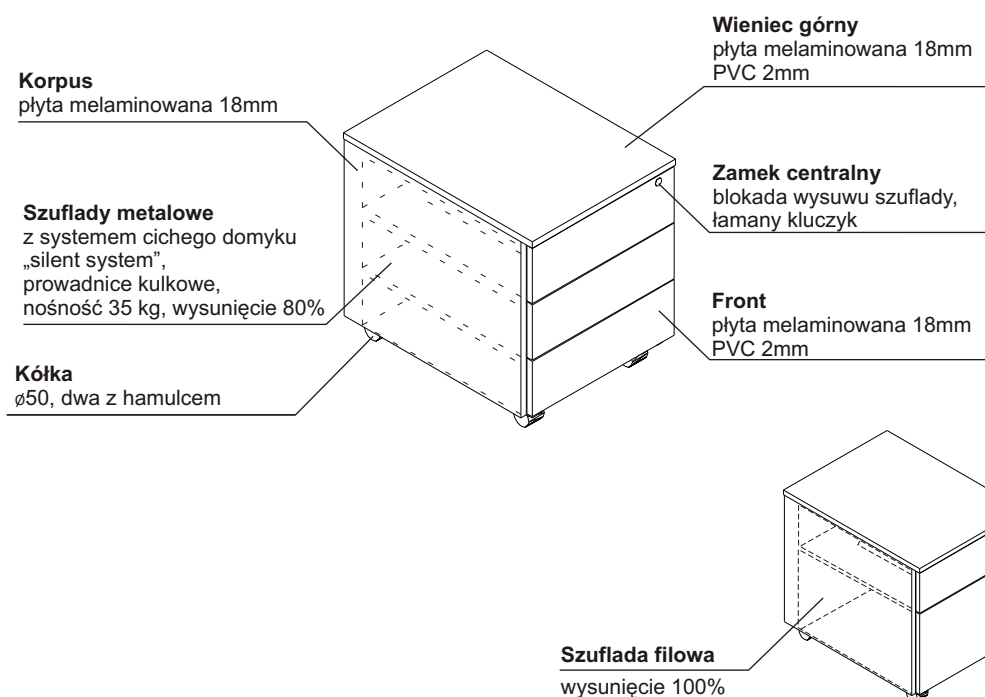

**OPIS TECHNICZNY**

**SZAFY**

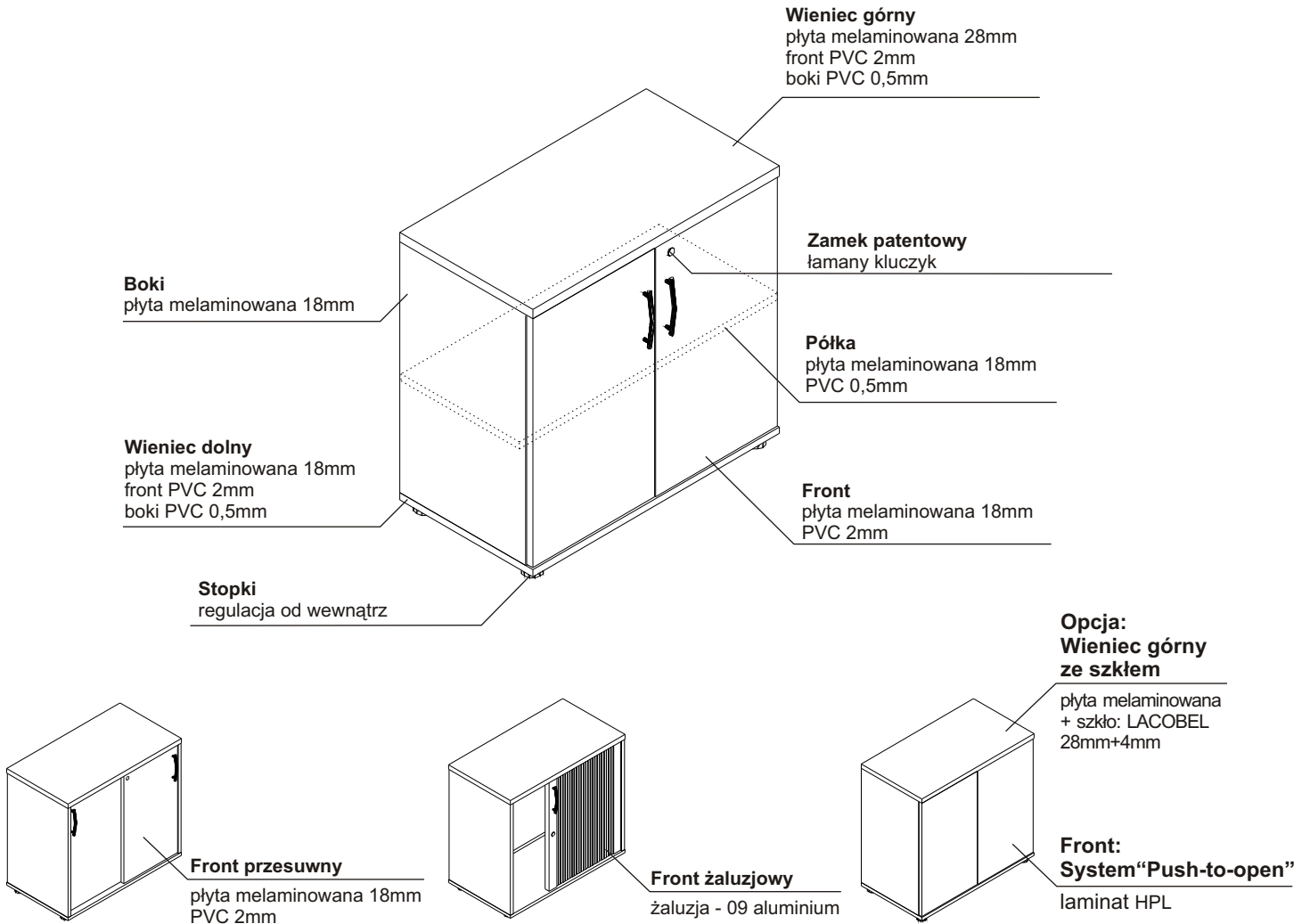

**SZAFKA ZS02, ZS03**

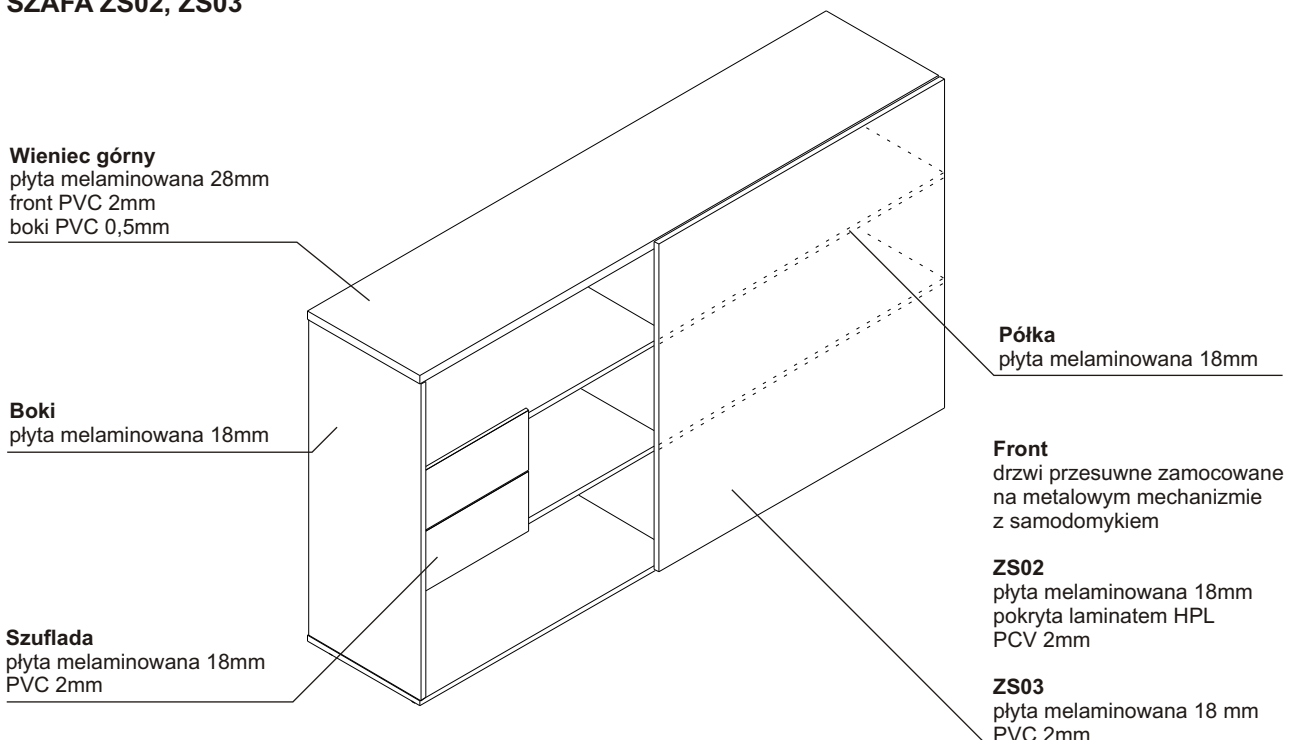

## KOLORYSTYKA

BLAT

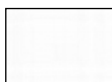
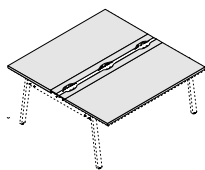

67 – BIAŁY PASTEL

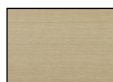

31 – DĄB KANADYJSKI

PRZYSTAWKA

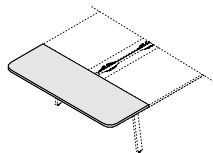

67 – BIAŁY PASTEL

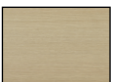

31 – DĄB KANADYJSKI

STELAŻ

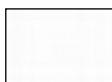
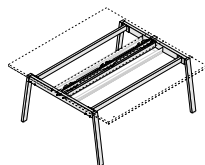

15 – BIAŁY

LISTWA

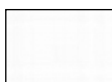
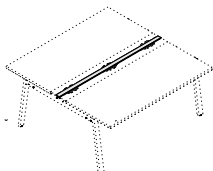

67 – BIAŁY PASTEL



31 – DĄB KANADYJSKI

OSŁONA DO BIURKA

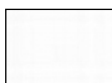
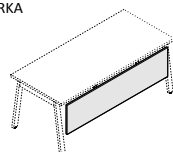

67 – BIAŁY PASTEL

PANEL TKANIOWY

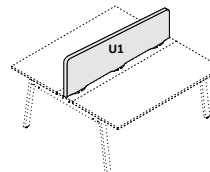
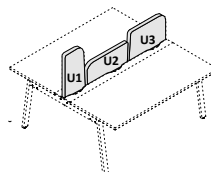
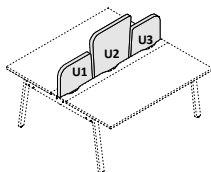
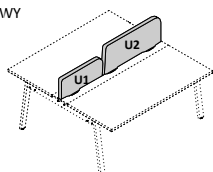

**U1 U2 U3**



NX2 - BEŻOWY



NX3 - POMARAŃCZOWY



NX5 - CZERWONY



NX9 - ZIELONY

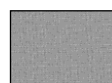

NX10 - SZARY



NX15 - GRANATOWY

## STOLIK

BLAT

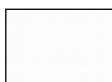

67 – BIAŁY PASTEL

STELAŻ

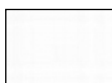

15 - BIAŁY

**KOLORYSTYKA - KONTENER SLK12, SLK13**

KONTENER

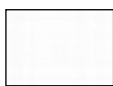
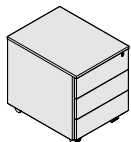

67 – BIAŁY PASTEL

PODUSZKA SKP13

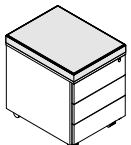

NX10 - SZARY

**KOLORYSTYKA SZAF**

SZAFKA ŻALUZIOWA

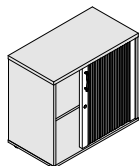

67 – BIAŁY PASTEL

SZAFKA Z DRZWIAMI PRZESUWNymi

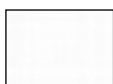
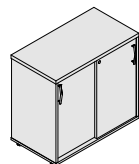

67 – BIAŁY PASTEL

WIENIEC GÓRNY I KORPUS

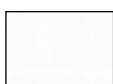
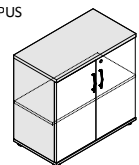

67 – BIAŁY PASTEL

FRONT

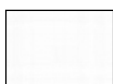
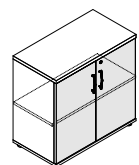

67 – BIAŁY PASTEL



31 – DĄB KANADYJSKI

WIENIEC GÓRNY I KORPUS

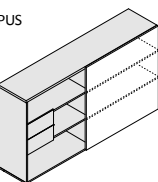

67 – BIAŁY PASTEL

FRONT HPL - ZS02

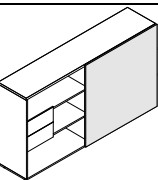

72 – ZIELONY POŁYSK

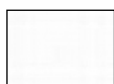

73 – BIAŁY POŁYSK



74 – POMARAŃCZOWY POŁYSK



82 – CZERWONY POŁYSK

FRONT - ZS03

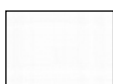
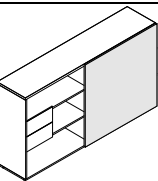

67 – BIAŁY PASTEL

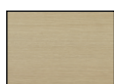

31 – DĄB KANADYJSKI

SZUFLADA DO ZS02, ZS03

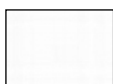
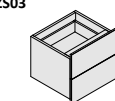

67 – BIAŁY PASTEL

WIDOK I RZUT OBIEKTU	WYMIARY			SYMBOL	CENA NETTO PLN	UWAGI
	Szerokość a / a'	Głębokość b / b'	Wysokość h			

**BIURKO**

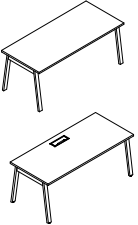
	1600	800	740	<b>BLF16</b>	1 000,-	
	1800	800	740	<b>BLF18</b>	1 100,-	
	1600	800	740	<b>BLF16M</b>	1 450,-	biurko z mediaboxem - 2 x RJ45 - 4 x 230 V
	1800	800	740	<b>BLF18M</b>	1 550,-	

**PRZYSTAWKA DO BIURKA**

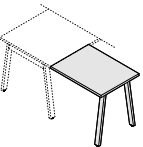
	800	600	740	<b>PLF04</b>	700,-	- przystawka z nogami do biurka BLF16, BLF18
---	-----	-----	-----	--------------	-------	---

**OSŁONY DO BIUREK**

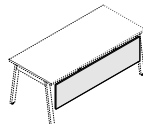
	1400	18	400	<b>UH4</b>	193,-	- osłona do biurka BLF16, BLF16M
	1600	18	400	<b>UH5</b>	205,-	- osłona do biurka BLF18, BLF18M

**PLATFORMA**

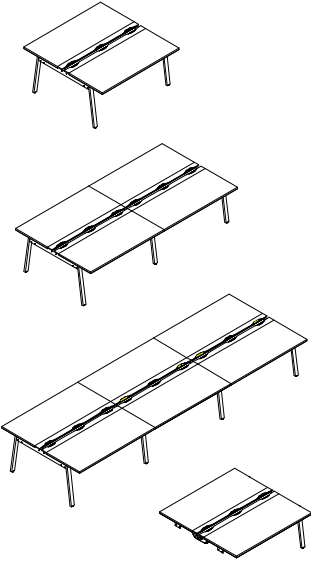
	1600	1640	740	<b>BLF01</b>	1 800,-	- układ dwustanowiskowy
	1800	1640	740	<b>BLF11</b>	1 950,-	
	3200	1640	740	<b>BLF02</b>	3 500,-	- układ cztero- stanowiskowy
	3600	1640	740	<b>BLF22</b>	3 800,-	
	4800	1640	740	<b>BLF03</b>	5 200,-	- układ sześciu- stanowiskowy
	5400	1640	740	<b>BLF33</b>	5 650,-	
	1600	1640	740	<b>BLF12</b>	1 700,-	- element do rozbudowy
	1800	1640	740	<b>BLF120</b>	1 850,-	

**PRZYSTAWKA DO PLATFORMY**

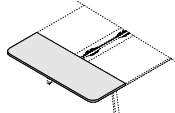
	1640	600	28	<b>PLF01</b>	680,-	- przystawka z elementami montażowymi
---	------	-----	----	--------------	-------	---

WIDOK I RZUT OBIEKTU	WYMIARY			SYMBOL	CENA NETTO PLN	UWAGI
	Szerokość a / a'	Głębokość b / b'	Wysokość h			

PANELE TKANINOWE

		<b>ZT01</b>	580,-	- wysokość ponad blat
		<b>ZT11</b>	610,-	
		<b>ZT02</b>	530,-	
		<b>ZT12</b>	560,-	
		<b>ZT03</b>	580,-	
		<b>ZT13</b>	610,-	
		<b>ZT16</b>	480,-	
		<b>ZT18</b>	500,-	

WIDOK I RZUT OBIEKTU	WYMIARY			SYMBOL	CENA NETTO PLN	UWAGI
	Szerokość a / a'	Głębokość b / b'	Wysokość h			

ELEMENTY DODATKOWE DO PLATFORMY

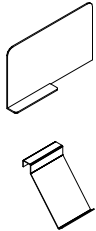
	500	300	5	<b>ZT10</b>	390,-	- panel wolnostojący, plexiglas
				<b>ZF04</b>	170,-	- zawieszka, plexiglas na panele

ZASTOSOWANIE ELEMENTÓW ZT10, ZF04

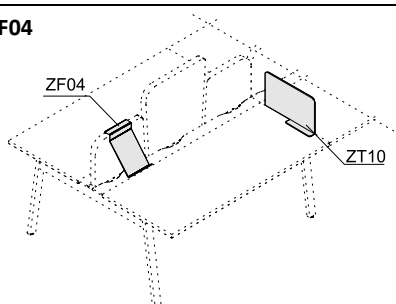

ELEMENTY DODATKOWE DO PLATFORMY

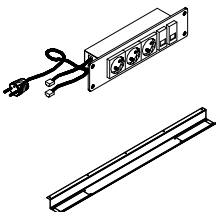
				<b>M02</b>	390,-	- 2 x RJ45 - 3 x 230 V
	1300			<b>E60</b>	290,-	

ZASTOSOWANIE ELEMENTÓW M02, E60

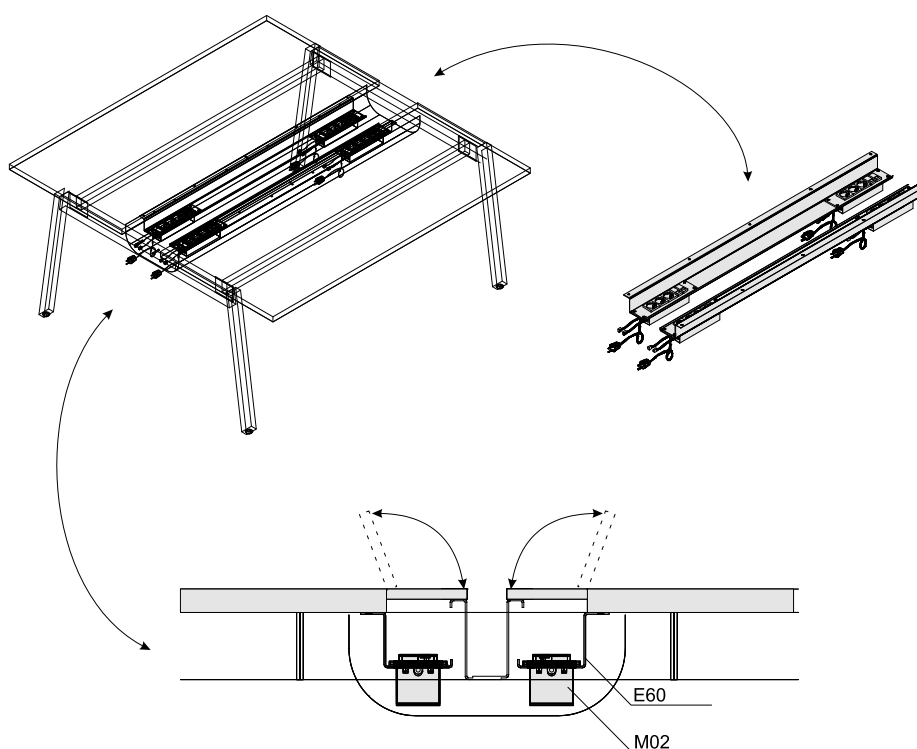

WIDOK I RZUT OBIEKTU	WYMIARY			SYMBOL	CENA NETTO PLN	UWAGI
	Szerokość a / a'	Głębokość b / b'	Wysokość h			

**ELEMENTY DODATKOWE DO PLATFORMY**

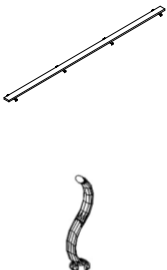
	1600			<b>PLF02</b>	250,-	- listwa do wypełniania zamiast paneli do stołu
	1800			<b>PLF03</b>	270,-	
				<b>S81</b>	116,-	- prowadzenie kabli (kręgosłup) kolor 09-aluminium

**ZASTOSOWANIE ELEMENTÓW S81, PLF02, PLF03**

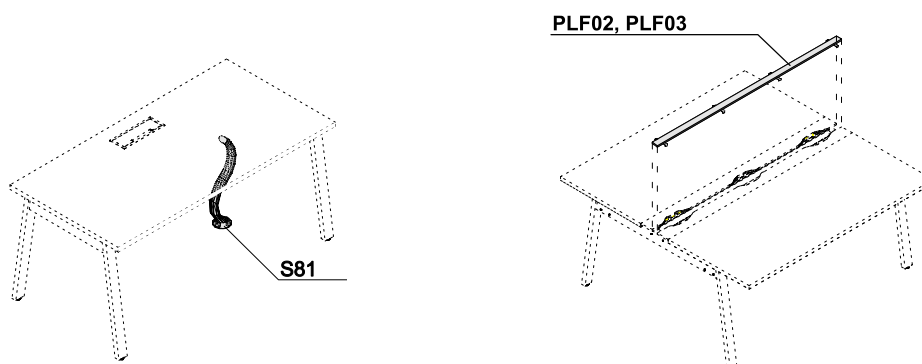

**STOLIK**

	Ø 800		740	<b>PLF80</b>	900,-	
---	-------	--	-----	--------------	-------	--

**KONTENERY**

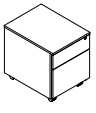
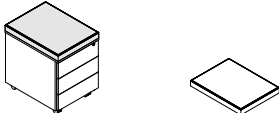

	470	616	580	<b>SLK13</b>	605,-	
	470	616	580	<b>SLK12</b>	590,-	- szuflada na file
	470	616	580	<b>SKP13</b>	320,-	- poduszka do kontenera SLK12, SLK13

WIDOK I RZUT OBIEKTU	WYMIARY			SYMBOL	CENA NETTO PLN	UWAGI
	Szerokość a / a'	Głębokość b / b'	Wysokość h			

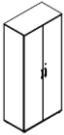
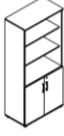
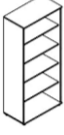
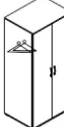

## SZAFY 50H

   	802	432	1833	<b>A5104C</b>	1 012,-	
	802	432	1833	<b>A5404C</b>	905,-	
	802	432	1833	<b>A5504C</b>	721,-	
	802	602	1833	<b>A6204C</b>	974,-	- ubraniowa z drążkiem

## SZAFY 30H





 	802	432	1129	<b>A3104C</b>	644,-	
	802	432	1129	<b>A3504C</b>	418,-	

## SZAFKA 20H



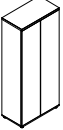
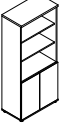

 	802	432	777	<b>A2104C</b>	506,-	
	802	432	777	<b>A2504C</b>	308,-	

WIDOK I RZUT OBIEKTU	WYMIARY			SYMBOL	CENA NETTO PLN	UWAGI
	Szerokość a / a'	Głębokość b / b'	Wysokość h			

**SZAFY Z FRONTEM HPL**

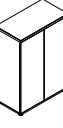

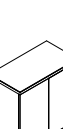
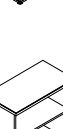
	802	432	1833	<b>A5104H</b>	1 580,-	
	802	432	1833	<b>A5404H</b>	1 000,-	
	802	432	1129	<b>A3104H</b>	1 060,-	
	802	432	1129	<b>A3404H</b>	860,-	
	802	432	777	<b>A2104H</b>	780,-	

**SZAFY Z FRONTEM HPL I SZKŁEM GÓRNYM**



	802	432	1129	<b>A3104HG</b>	1 330,-	
	802	432	1129	<b>A3404HG</b>	1 130,-	
	802	432	777	<b>A2104HG</b>	1 050,-	
	802	432	777	<b>A2504HG</b>	560,-	
- szkło górne 	802	432	33	<b>A800GT</b>	270,-	

WIDOK I RZUT OBIEKTU	WYMIARY			SYMBOL	CENA NETTO PLN	UWAGI
	Szerokość a / a'	Głębokość b / b'	Wysokość h			

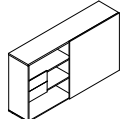
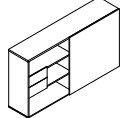

## SZAFY ŻALUZIOWE

	1200	434	1129	<b>A3Z06C</b>	1 495,-	
	800	434	740	<b>A2Z04C</b>	895,-	
	1200	434	740	<b>A2Z06C</b>	1 120,-	

## SZAFY PRZESUWNE

	2000	434	1129	<b>ZS02</b>	1 890,-	- front HPL
	2000	434	1129	<b>ZS03</b>	1 590,-	- front melamina
	428	385	403	<b>ZSZ01</b>	260,-	- szuflada do szaf ZS02, ZS03

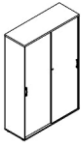
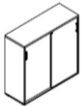
## SZAFY PRZESUWNE

	1200	434	1833	<b>A5P06C</b>	1 405,-	
	1200	434	1129	<b>A3P06C</b>	1 050,-	
	800	434	740	<b>A2P04C</b>	615,-	
	1200	434	740	<b>A2P06C</b>	865,-	